

TOP VIEW

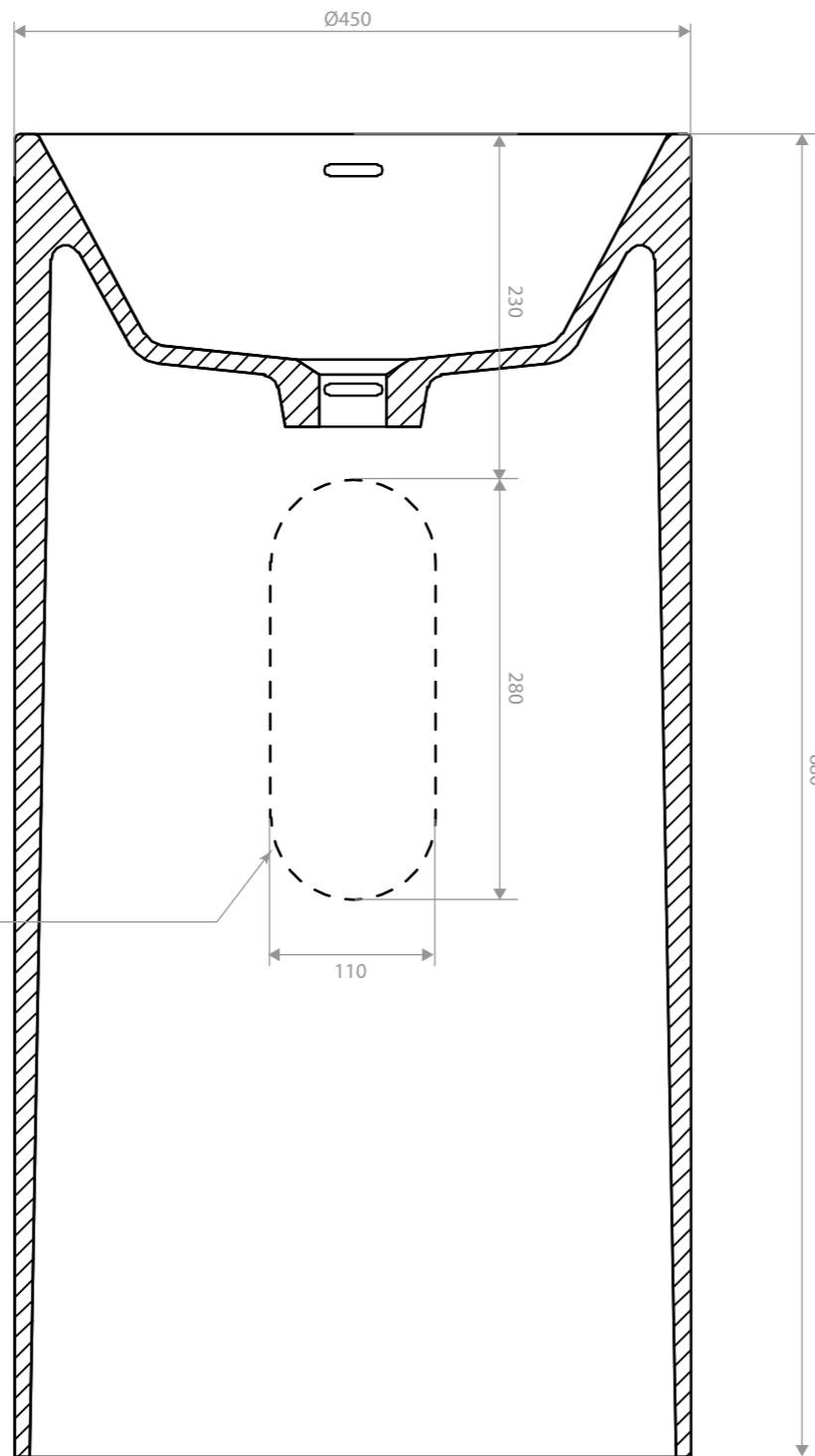

FRONT VIEW (CROSS SECTION)

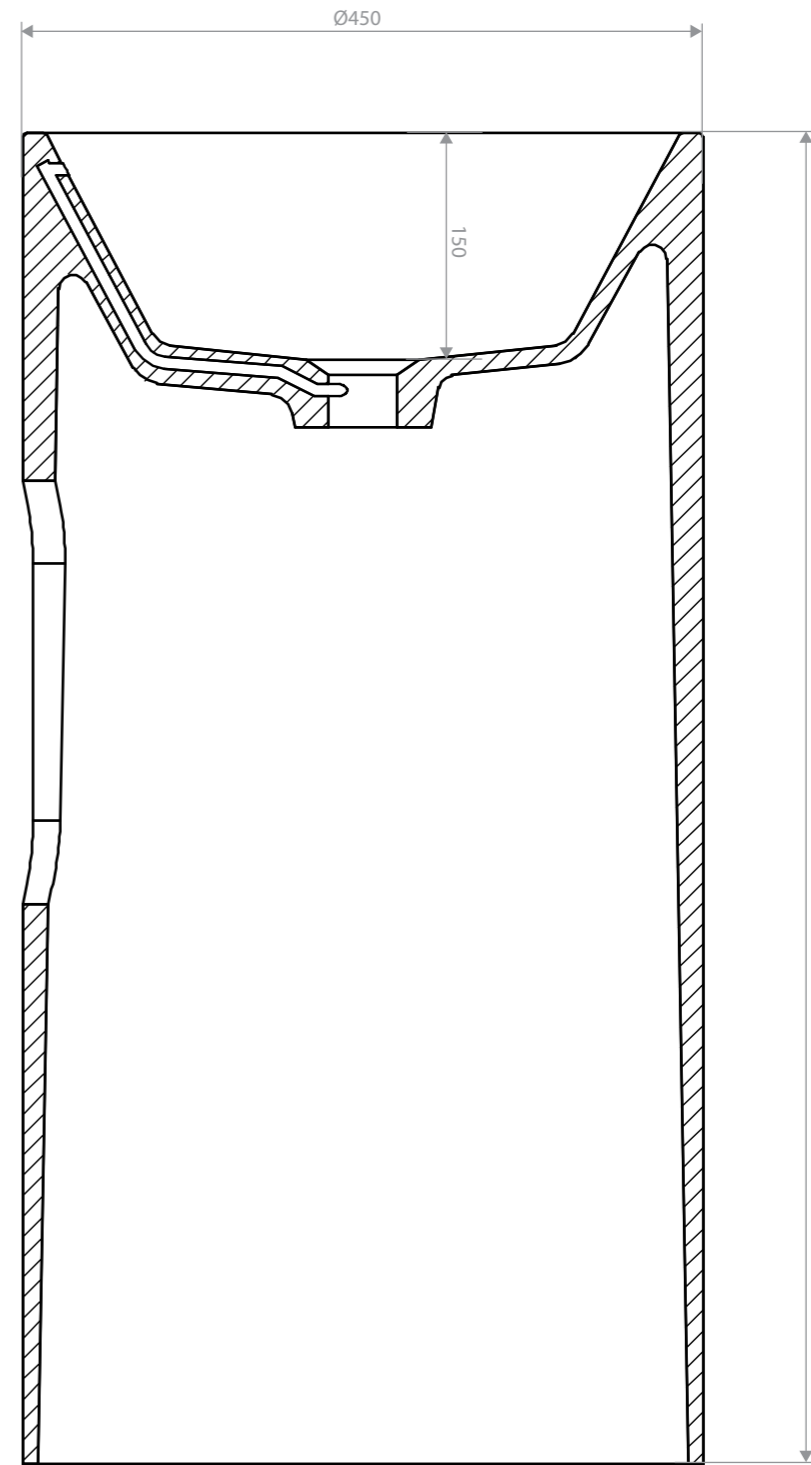

SIDE VIEW (CROSS SECTION)

DESCRIPTION

Freestanding basin with access opening (optional) and overflow.
Comes with push pop-up waste in stone composite cover.

FINISHING

Matte White

MATERIAL

Gel Coated Stone Composite

NOTE

Basin Weight : approx 45kg.

REVISION

NO	DATE	REVISION



ENNE CREATIONS LIMITED
UNIT 1, 9/F, WO HING COMMERCIAL BUILDING,
11, WING WO STREET, CENTRAL, HONG KONG.
TEL : +852 3594 6972

PRODUCT CODE

10423

DRAWING NO	REV	DATE
	0	13.07.20

DRAWN BY : JH

CHECKED BY :

PAGE	SCALE	A3
01 OF 01	1:5	

- All dimensions are in mm unless otherwise stated, dimensional tolerance of ±1% manufacturing standards.
- Installations are based on recommendation only.
- This drawing is property of Enne Creations Limited and is not to be reproduced or copied in whole or in part.
- It is only to be used for the project and site specifically indentified herein and is not to be used in any other project.
- It is to be returned upon request.